



U-MATCH Series Ceiling Cassette

Installation Manual Heat Pumps



Models

Indoor Unit	Outdoor Unit
UMAT18HP230V1AC	UMAT18HP230V1AO
UMAT24HP230V1AC	UMAT24HP230V1AO
UMAT30HP230V1AC	UMAT30HP230V1AO
UMAT36HP230V1AC	UMAT36HP230V1AO
UMAT42HP230V1AC	UMAT42HP230V1AO
UMAT48HP230V1AC	UMAT48HP230V1AO

- Thank you for choosing our commercial air conditioners. Please read this installation manual carefully before operation and retain it for future reference.
- This installation manual is subject to change without prior notice for product improvement.
- GREE Electric Appliances, Inc. of Zhuhai reserves the final right to interpret this manual.

Contents

1 Safety Precautions	1
2 Outline of the Unit and Main Parts.....	3
3 Preparation for Installation.....	4
3.1 Standard Accessory Parts	4
3.2 Selection of the Installation Location.....	5
3.3 Connection Pipe Requirement	6
3.4 Electrical Requirement	7
4 Installation of the Unit.....	8
4.1 Installation of the Indoor Unit.....	8
4.2 Installation of the Outdoor Unit.....	11
4.3 Installation of the Connection Pipe.....	12
4.4 Vacuum and Gas Leakage Inspection.....	16
4.5 Installation of the Drain Hose	18
4.6 Panel Installation	21
4.7 Electrical Wiring.....	23
5 Installation of Controllers	28
6 Test Running.....	28
6.1 Trial Operation and Testing.....	28
6.2 Working Temperature Range.....	30
7 Troubleshooting and Maintenance	30
7.1 Troubleshooting	30
7.2 Routine Maintenance	31

1 Safety Precautions

	This is the safety alert symbol. It is used to alert you to potential personal injury hazards. Obey all safety messages that follow this symbol to avoid possible injury or death.
⚠ WARNING	This mark indicates procedures which, if improperly performed, might lead to the death or serious injury of the user.
⚠ CAUTION	This mark indicates procedures which, if improperly performed, might possibly result in personal harm to the user, or damage to property.
NOTICE	Notice is used to address practices not related to personal injury.

⚠ WARNING	
(1).	Instructions for installation and use of this product are provided by the manufacturer.
(2).	Installation must be performed in accordance with the requirements of NEC and CEC by authorized personnel only.
(3).	Installation should be performed by the dealer or professional person. Improper installation may cause water leakage, electrical shock, or fire.
(4).	Install the air conditioner according to the instructions given in this manual. Incomplete installation may cause water leakage, electrical shock, or fire.
(5).	Be sure to use the supplied or specified installation parts. Use of other parts may cause water leakage, electric shock or fire.
(6).	Install the air conditioner on a solid base that can support the weight of the unit. An inadequate base or incomplete installation may cause injury in the event the unit falls off .
(7).	Electrical work should be carried out in accordance with the installation manual and the national electrical wiring rules or code of practice. Insufficient capacity or incomplete electrical work may cause electric shock or fire.
(8).	Be sure to use an independent power circuit. Never use a power supply shared with other appliances.
(9).	For wiring, use a cable length enough to cover the entire distance with no splices. Do not use an extension cord. Do not put other loads on the power wire. (Failure to do so may cause abnormal heat, electric shock or fire.)
(10).	Use the specified types of wires for electrical connections between indoor unit and outdoor unit. Properly strain relief the interconnecting wires so the terminals receive no external stresses. Incomplete connections or clamping may cause terminal overheating or fire.
(11).	After connecting interconnecting and supply wiring, be sure to secure the cables so that they do not put undue force on the electrical covers or panels. Install covers over the wires. Improper installation may cause terminal overheating, electric shock, or fire.
(12).	If any refrigerant has leaked out during installation, ventilate the room. (The refrigerant generates toxic gas if exposed to flames.)
(13).	After all installation is completed, make sure there's no refrigerant leaking out of the system. (The refrigerant produces toxic gas if exposed to flames.)

U-match Series Cassette Type Unit

- | |
|--|
| (14). When installing or repairing the system, be sure to keep the refrigerant circuit free from substances other than the specified refrigerant (R410A), such as air. (Any presence of air or other foreign substances in the refrigerant circuit causes an abnormal pressure rise or rupture, resulting in injury.) |
| (15). During vacuum pump operation, stop the compressor before removing the refrigerant piping. If the compressor is still running and the stop valve is open during vacuum pump operation, air will be sucked in when the refrigerant piping is removed. There will be abnormal pressure in the refrigeration circuit, which may cause damage or injury |
| (16). During installation, attach the refrigerant piping securely before running the compressor. Compressor is not attached and the stop valve is open during pump-down, air will be sucked in, causing abnormal pressure in the refrigeration circuit which may cause damage or injury. |
| (17). Be sure to establish an earth ground. Do not earth ground the unit to a utility pipe, arrester, or telephone earth ground. Incomplete earth ground may cause electric shock, or fire. A high surge current from lightning or other sources may cause damage to the air conditioner. |
| (18). Be sure to install an earth ground leakage or GFI breaker. Failure to install an earth ground leakage or GFI breaker may result in electric shocks, or fire. |
| (19). This appliance is not intended for use by persons (including children) with reduced physical, sensory or mental capabilities, or lack of experience and knowledge, unless they have been given supervision or instruction concerning use of the appliance by a person responsible for their safety. |
| (20). Children should be supervised to ensure that they do not play with the appliance. |

▲ CAUTION

- | |
|---|
| (1). Do not install the air conditioner in a place where inflammable gas is stored. |
| (2). Install drain piping according to the instructions of this manual. Inadequate piping may cause overflowing and property damage. |
| (3). Tighten the flare nut according to the specified method with a torque wrench. If the flare nut is over tighten, the flare connection may fail over time and cause refrigerant leakage. |

2 Outline of the Unit and Main Parts

Indoor

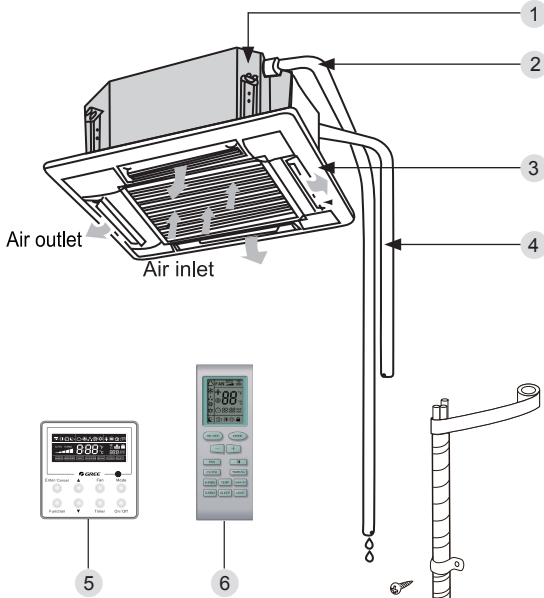

Outdoor

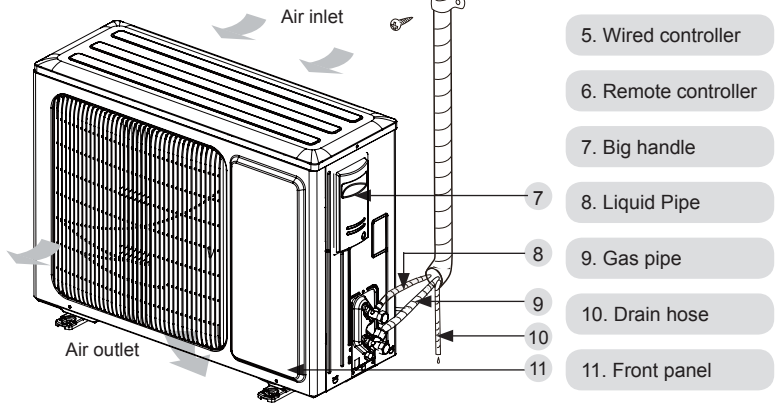

Fig. 2.1

NOTICE

The connection pipe, drain pipe, and electrical wiring should be done by a qualified technician.

3 Preparation for Installation

3.1 Standard Parts

The standard parts listed below are furnished and should be used as required.

Table 3.1















Indoor Unit Accessories				
No.	Name	Appearance	Q'ty	Usage
1	Drain Hose		1	To connect with field supplied drain pipe
2	Screw with Washer		4	To secure the hook on the cabinet of the unit.
3	Washer		10	To be used together with the hanger bolt for installing the unit.
4	Installation templete		1	Used ceiling drilling
5	Gasket Mounting Board		4	To prevent gasket from falling off
6	Remote Controller +Batteries		1+2	To control the indoor unit
7	Sealing Plaster		1	
8	Cable Clamp		4	To fasten the insulation to pipe
9	Pipe Insulation		1	To insulate the gas pipe
10	Pipe Insulation		1	To insulate the liquid pipe
11	Insulation		4	To insulate the drain pipe
12	Flare Nut		1	To connect gas pipe
13	Flare Nut		1	To connect liquid pipe
14	Service Valve Cap		2	To protect service port

Table 3.2

Outdoor Unit Accessories				
No.	Name	Appearance	Q'ty	Usage
1	Drain Plug		2 or 3	To plug the unused drain hole.
2	Drainage Connector		1	To connect field supplied drain hose

3.2 Selection of the Installation Location

⚠WARNING

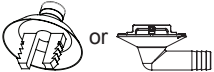
- ①. The outdoor unit must be installed on a mounting pad which can withstand the weight of the unit. Otherwise, the unit may fall off and cause damage.
- ②. Do not install the unit at a place where combustible gas is stored.
- ③. Do not install the unit near heat source , steam, or flammable gas.

Decide the installation location with the customer as follows:

3.2.1 Indoor Unit

Select an installation site where the following conditions are fulfilled and that meets your customer's requirement.

- (1). Obstruction should be removed from air inlet and air outlet of the indoor unit so that the airflow can reach every corner of the room.
- (2). Make sure that the installation meets the minimum installation clearance dimensions.
- (3). Select a ceiling support that can withstand 4 times of the weight of the indoor unit and would not increase the operating noise and vibration of the unit.
- (4). Select a location where a level installation is guaranteed.
- (5). Select the place where it's easy to drain out the condensate water, and connect with outdoor unit.
- (6). Make sure that there is enough space for care and maintenance, and the height between the indoor unit and floor is a minimum 6 feet.
- (7). When installing the suspension bolt, check if the installation location can support 4 times of the weight of the unit. If not, reinforce it before starting the installation.

Note: Kitchen and dining room installations may have reduce capacity over time due to grease and dirt accumulation on indoor fan and coil.

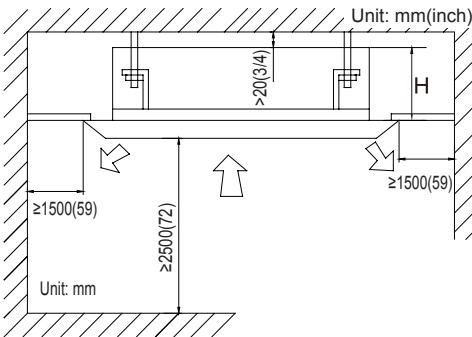

Table 3.3

Models	H mm(inch)
UMAT18HP230V1AC	255(10)
UMAT24HP230V1AC	260(10-1/4)
UMAT30HP230V1AC	340(13-3/8)
UMAT36HP230V1AC	340(13-3/8)
UMAT42HP230V1AC	340(13-3/8)
UMAT48HP230V1AC	320(12-5/8)

Fig.3.1

3.2.2 Outdoor Unit

⚠ WARNING

- ①. The unit should be installed level right to left and front to back.
- ②. During installation, if the outdoor unit has to be exposed to strong wind, it must be properly secured.

If possible, do not install the unit where it will be exposed to direct sunlight.

- (1). Install the outdoor unit at a place where there's not much dust .
- (2). Install the outdoor unit where it is convenient to connect with the indoor unit.
- (3). Install the outdoor unit where the condensate water can be drained out freely during heating operation.
- (4). Do not place animals and plants in the path of the warm discharge air.
- (5). Take the air conditioner weight into account .
- (6). Install the outdoor unit in a location that is capable of withstanding the weight of the unit.□□
- (7). Provide the minimum installation clearance dimensions shown in Fig.3.2, so that the air flow is not blocked.

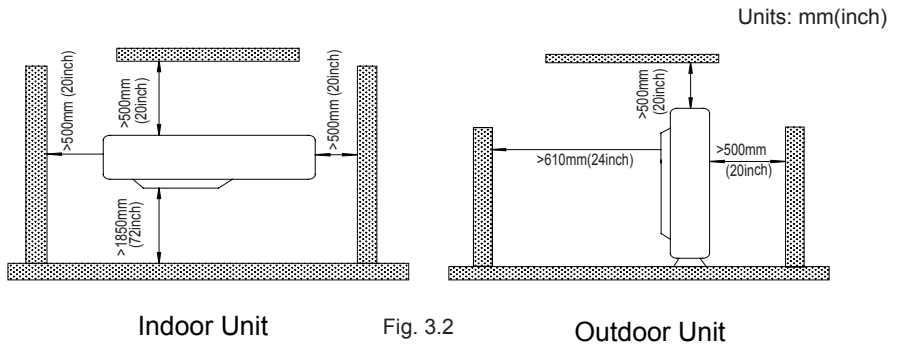

3.3 Connection Pipe Requirement

⚠ CAUTION

The maximum length of the connection pipe is listed in the table below. Do not install the unit in the location where the distance exceeds the maximum length of the connection pipe.□□

Table 3.4

Model \ Item	Size of Fitting Pipe mm(Inch)		Max. Pipe Length mm(feet)	Max. Height Difference between Indoor Unit and Outdoor Unit mm(feet)	Drain Hose(Outer Diameter × wall Thickness) mm(Inch)
	Liquid	Gas			
UMAT18HP230V1AC UMAT18HP230V1AO	6(1/4)	12.7(1/2)	20(66)	15(49)	Φ25×1.5 (Φ1×3/0.05)
UMAT24HP230V1AC UMAT24HP230V1AO	9.5(3/8)	16(5/8)	30(98)	15(49)	
UMAT30HP230V1AC UMAT30HP230V1AO			30(98)	15(49)	
UMAT36HP230V1AC UMAT36HP230V1AO			30(98)	15(49)	
UMAT42HP230V1AC UMAT42HP230V1AO			50(164)	30(98)	
UMAT48HP230V1AC UMAT48HP230V1AO			50(164)	30(98)	

The connection pipe should be insulated with proper water-proof insulating material.

The pipe wall thickness shall be 0.5-1.0mm(0.05 - 0.1inch) and the pipe wall shall be able to withstand the pressure up to 6.0 MPa(870psig).

3.4 Electrical Requirement

Electric Wire Size and Fuse Capacity.

Table 3.5

Indoor Units	Power Supply	Main PCB On-Board Fuse	Min. Circuit Ampacity (MCA)	Max Overcurrent Protection(MOCP)
	V/Ph/Hz	Amp	Amp	Amp
UMAT18HP230V1AC	208V/230V 1 60Hz	5	1	15
UMAT24HP230V1AC	208V/230V 1 60Hz	5	1	15
UMAT30HP230V1AC	208V/230V 1 60Hz	5	1.5	15
UMAT36HP230V1AC	208V/230V 1 60Hz	5	1.5	15
UMAT42HP230V1AC	208V/230V 1 60Hz	5	1.5	15
UMAT48HP230V1AC	208V/230V 1 60Hz	5	2	15

Table 3.6

Outdoor Unit	Power Supply	Main PCB On-Board Fuse	Min. Circuit Ampacity (MCA)	Max Overcurrent Protection(MOCP)
	V/Ph/Hz	Amp	Amp	Amp
UMAT18HP230V1AO	208V/230V 1 60Hz	5	17	25
UMAT24HP230V1AO	208V/230V 1 60Hz	5	24	40
UMAT30HP230V1AO	208V/230V 1 60Hz	5	24	40
UMAT36HP230V1AO	208V/230V 1 60Hz	5	29	45
UMAT42HP230V1AO	208V/230V 1 60Hz	5	31	50
UMAT48HP230V1AO	208V/230V 1 60Hz	5	45	70

Notes:

- ①. Install electrical disconnect switches per NEC and local codes.

- ②. Take 2 pieces of 18 AWG wire for the communication lines between indoor and outdoor unit, with a maximum length of 50m(164feet). Select the appropriate line length as per the actual installation conditions. The communication wire can not be twisted together. For the smaller units ($\leq 30K$), it's recommended to use up to a maximum of 20m (66feet) long communication line.
- ③. Take 2 pieces of 18 AWG wire for the communication lines between the wired controller and the indoor unit.
Select the appropriate wire length as per the actual installation conditions. The communication lines can not be twisted together. It's recommended to use up to a maximum 8m(26feet) long communication line.
- ④. The wire size of the communication line should be no less than 18 AWG.

4 Installation of the Unit

4.1 Installation of the Indoor Unit

4.1.1 Indoor unit dimension

18K:

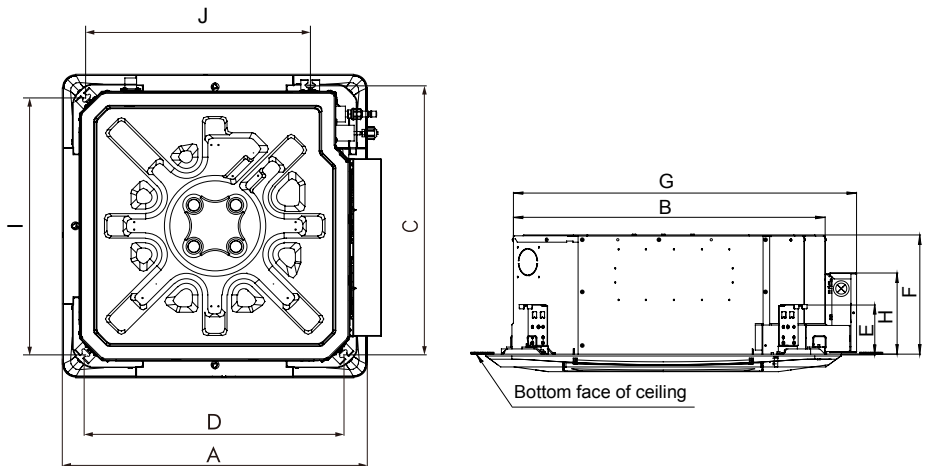

Table 4.1

Unit: mm(inch)

Item	A	B	C	D	E	F	G	H	I	J
Model										
UMAT18HP230V1AC	670 (26-3/8)	596 (23-1/2)	592 (23-1/4)	575 (22-5/8)	145 (5-3/4)	240 (9-1/2)	665 (26-1/8)	236 (9-1/4)	575 (22-5/8)	505 (19-7/8)

24~42K:

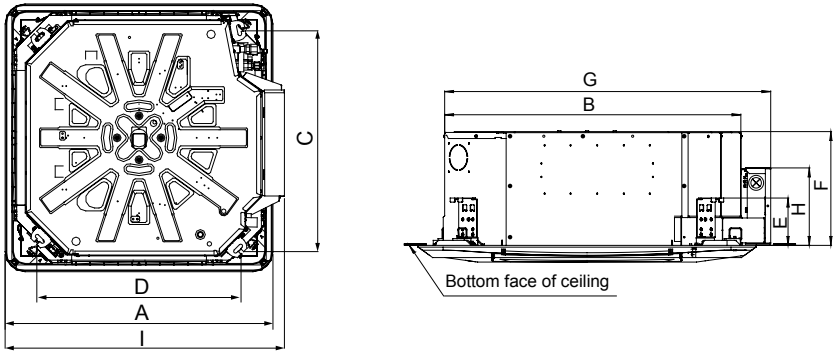

Table 4.2

Unit: mm(inch)

Item Model	A	B	C	D	E	F	G	H	I
UMAT24HP230V1AC	950 (37-3/8)	833 (32-3/4)	780 (30-3/4)	680 (26-3/4)	160 (6-1/4)	240 (9-1/2)	917 (36-1/8)	215 (8-1/2)	993 (39-1/8)
UMAT30HP230V1AC	950 (37-3/8)	833 (32-3/4)	780 (30-3/4)	680 (26-3/4)	160 (6-1/4)	320 (12-5/8)	917 (36-1/8)	215 (8-1/2)	993 (39-1/8)
UMAT36HP230V1AC	950 (37-3/8)	833 (32-3/4)	780 (30-3/4)	680 (26-3/4)	160 (6-1/4)	320 (12-5/8)	917 (36-1/8)	215 (8-1/2)	993 (39-1/8)
UMAT42HP230V1AC	950 (37-3/8)	833 (32-3/4)	780 (30-3/4)	680 (26-3/4)	160 (6-1/4)	320 (12-5/8)	917 (36-1/8)	215 (8-1/2)	993 (39-1/8)

48K:

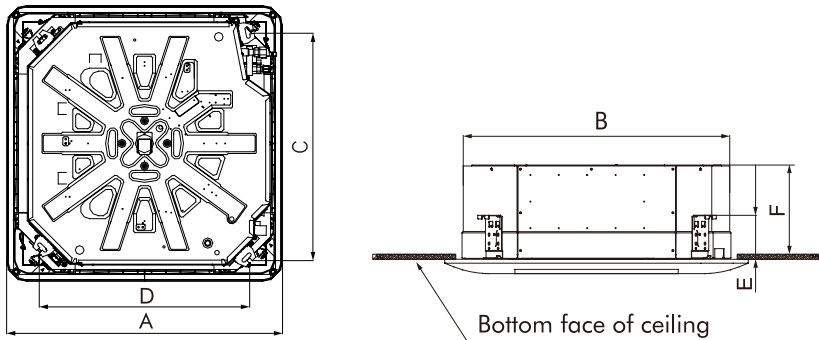

Fig.4.1

Table 4.3

Unit: mm(inch)

Item Model	A	B	C	D	E	F
UMAT48HP230V1AC□□	1040 (41)	910 (35-7/8)	842 (33-1/8)	788 (31)	170 (6-3/4)	290 (11-3/8)

4.1.2 Installing the Suspension Bolts

- (1). Using the installation template, drill holes for bolts (four holes). (Fig. 4.2)
- (2). Install the bolts to the ceiling at a place strong enough to hold the unit. Mark the bolt positions from the installation template. With a drill, drill four 12.7mm (1/2inch) diameter holes. (Fig. 4.3)
- (3). Insert the anchor bolts into the drilled holes, and drive the pins completely into the anchor bolts with a hammer. (Fig. 4.4)

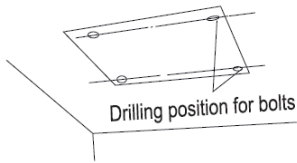

Fig. 4.2

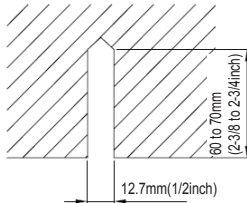

Fig. 4.3

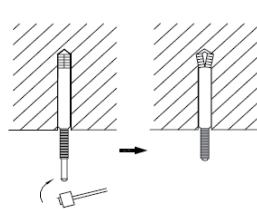

Fig. 4.4

4.1.3 Installing the Main Body Unit

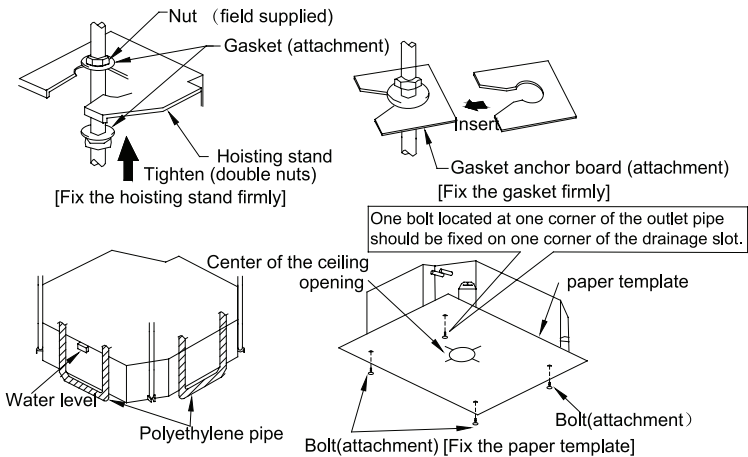

Fig. 4.5

- (1). Install the hoisting stand on the hoisting screw by using nuts and gaskets at both upper and lower sides of the hoisting stand. To prevent the gasket from breaking off, a gasket anchor board can be helpful.

- (2). Install the paper template on the unit, and fix the drain hose at the outlet vent.
- (3). Adjust the unit to the best position.
- (4). Check if the unit is installed horizontally level in four directions. If not, the water pump and the float switch can't operate normally, and lead to water leakage.
- (5). Remove the gasket anchor board and tighten the nut remained.
- (6). Remove the paper template.

4.1.4 Leveling

After indoor unit is installed, the level test must be conducted to make sure that the unit is installed level (right to left and front to back), as shown below.

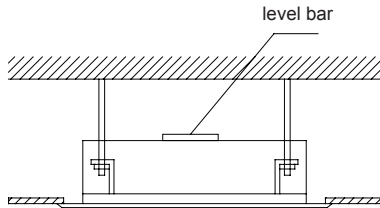

Fig.4.6

4.2 Installation of the Outdoor Unit

⚠WARNING

- ① . The unit should be installed horizontally level.
- ② . During installation, if the outdoor unit has to be exposed to strong wind, it must be properly secured.

4.2.1 Outdoor unit dimension

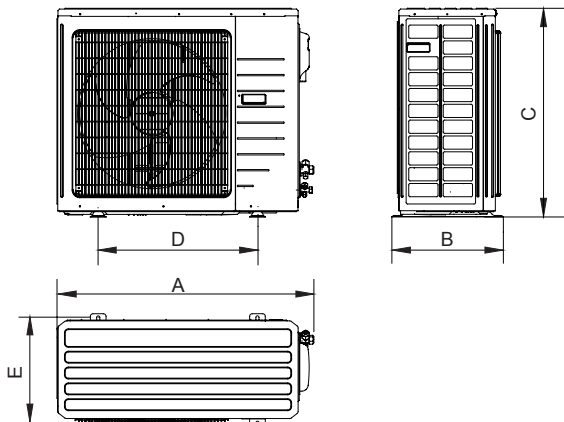

Fig.4.7

Table 4.4

Unit: mm(inch)

Item Model	A	B	C	D	E
UMAT18HP230V1AO	955 (37-5/8)	396 (15-5/8)	700 (27-1/2)	560 (22)	360 (14-1/8)
UMAT24HP230V1AO	980 (38-5/8)	427 (16-3/4)	790 (31-1/8)	610 (24)	395 (15-1/2)
UMAT30HP230V1AO	980 (38-5/8)	427 (16-3/4)	790 (31-1/8)	610 (24)	395 (15-1/2)
UMAT36HP230V1AO	1107 (43-5/8)	440 (17-3/8)	1100 (43-1/4)	631 (24-7/8)	400 (15-3/4)
UMAT42HP230V1AO	958 (37-3/4)	412 (16-1/4)	1349 (53-1/8)	572 (22-1/2)	376 (14-3/4)
UMAT48HP230V1AO	958 (37-3/4)	412 (16-1/4)	1349 (53-1/8)	572 (22-1/2)	376 (14-3/4)

4.2.2 Condensate Drainage of the Outdoor Unit(Fig.4.8)

- (1). It's required to install the outdoor unit with a drain to drain out condensate water during heating operation. (only for the heat pump unit)
- (2). When installing the drain, all other holes must be blocked to avoid water leak, except the selected mounting hole. □□
- (3). Installation Method: Insert the drain joint into the selected hole located in the basepan of the outdoor unit and then connect the drain pipe to the drain joint.

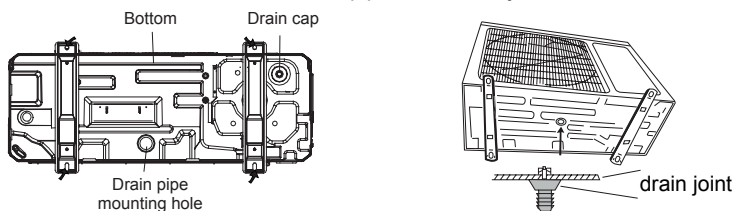

Fig. 4.8

4.3 Installation of the Connection Pipe

4.3.1 Flare Processing

- (1). Cut the connection pipe with the pipe cutter and remove the burrs.
- (2). Hold the pipe downward to prevent cuttings from entering the pipe.
- (3). Remove the flare nuts at the stop valve of the outdoor unit and inside the accessory bag of the indoor unit, then insert them on to the connection pipe, then, flare the connection pipe end with a flaring tool.
- (4). Check if the flare is spread evenly and there are no cracks (see Fig. 4.9).

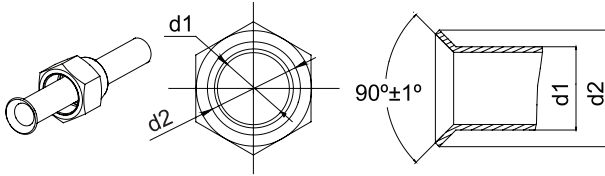

Fig. 4.9

4.3.2 Bending Pipes

(1). The pipes can be shaped by your hands. Be careful not to break or kink them.

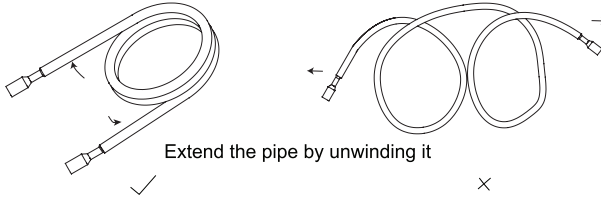

Fig.4.10

(2). Do not bend the pipes in an angle more than 90°.

(3). When pipes are bent or stretched repeatedly, it may damaged them. Do not bend or stretch pipes more than three times. □□

(4). To avoid damaging pipes during bending, use sharp cutter as shown

in Fig 4.12 to cut the heat insulating pipe, and

then bend the pipe with a bending tool.. When the pipe is bent, be sure to put the heat insulating pipe back on the pipe and then stick it with tape.

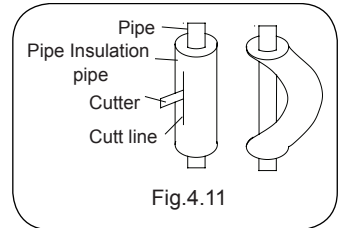

Fig.4.11

▲ CAUTION

①. To prevent breaking of the pipe, avoid sharp bends. Bend the pipe with a radius of curvature larger than 150mm(6inch).

②. If the pipe is bent repeatedly at the same place, it may become damaged or broken.

4.3.3 Connecting the Pipe at the Indoor Unit Side

Remove the caps and plugs from the pipes.

▲ CAUTION

①. Be sure to point the connection pipe at the stop valve correctly. If the centering is improper, the flare nut cannot be tightened smoothly. If not turning smoothly, the threads will be damaged.

②. For preventing dust and impurities getting into the pipe system, do not remove the flare nut until the connection pipe is connected.

When connecting the pipe to the unit or removing it from the unit, use both the spanner and the torque wrench.(Fig.4.12)

U-match Series Cassette Type Unit

When connecting flare nuts, smear both inside and outside with refrigeration oil, screw it hand tight and then tighten it with the spanner and torque wrench.

Refer to Table 4.5 to check for proper torque(Over tightening will damage the nut and lead to leakage).

Examine and test the connection pipe for leaks, and then insulate the connection pipe, as shown in the Fig.4.12.

Use the medium-sized insulaton strip to insulate the coupler of the gas pipe.

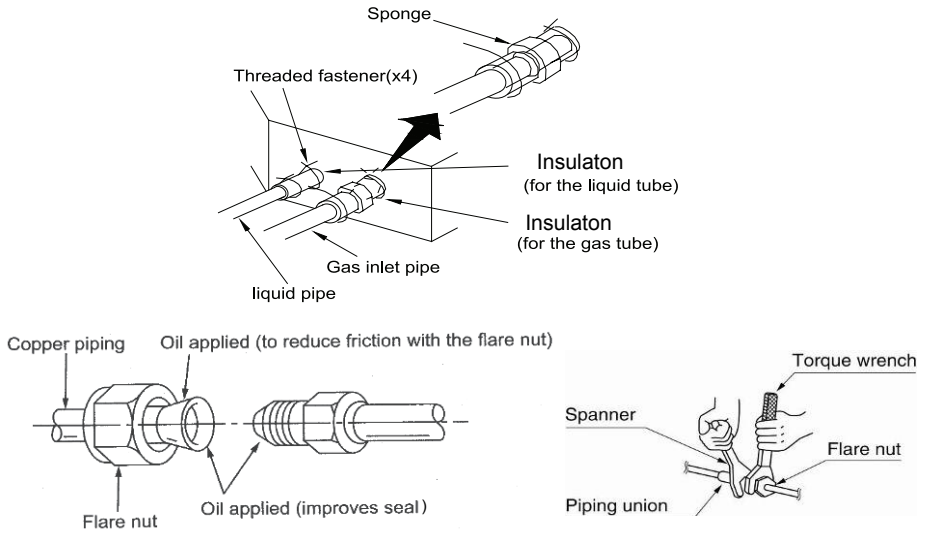

Fig.4.12

Table 4.5 Flare nut tightening torque

Pipe Diameter	Tightening Torque
6mm(1/4inch)	15-30N·m(11-22ft.-1bs.)
9.5mm(3/8 inch)	35-40N·m(26-29ft.-1bs.)
12.7mm(1/2 inch)	45-50N·m(33-37ft.-1bs.)
16mm(5/8 inch)	60-65N·m(44-48ft.-1bs.)

⚠ CAUTION

Be sure to connect the gas pipe when liquid pipe is connected.

4.3.4 Connecting the Pipes at the Outdoor

Tighten the flare nut of the connection pipe at the outdoor unit valve connector. The tightening method is the same torque method used on the indoor side.

4.3.5 Checking the Pipe Connections for Gas Leaks

For both indoor and outdoor unit side, check for gas leaks at connection joints with gas leakage detector.

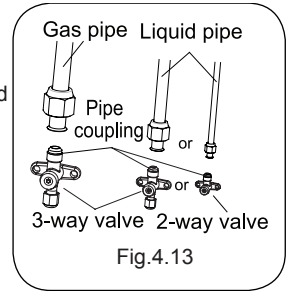

4.3.6 Insulation on the Pipe Joints (Indoor Side Only)

Completely cover connection joints with insulation to prevent sweating.

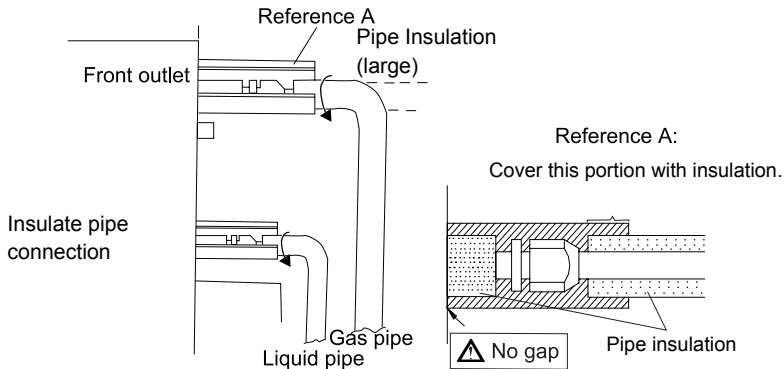

4.3.7 Liquid Pipe and Drain Pipe

If the outdoor unit is installed lower than the indoor unit (See Fig.4.15)

- (1). The drain pipe should be on the ground. The end of the drain pipe can't be submerged in water. All pipes must be bundled to the wall with attaching clamp.
- (2). If taping pipe, it must be done from bottom to top.
- (3). All pipes are bound together by cable clamps and restrained to the wall with attaching clamp.

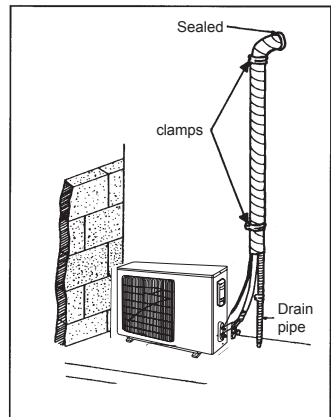

If the outdoor unit is installed higher than the indoor unit (See Fig.4.16)

- (1). If taping, it must be done from lower to the upper part.
- (2). All pipes are bound together with cable clamps. The drain hose must contain a trap to prevent water from returning to the indoor unit.
- (3). Restraint all pipes to the wall with attaching clamp.

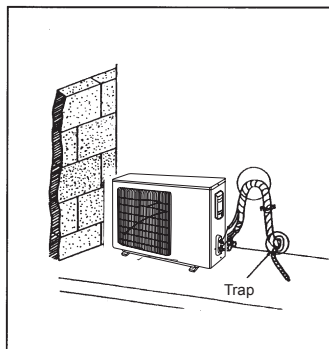

Fig.4.16

4.4 Vacuum and Gas Leakage Inspection

▲ CAUTION

Always use a vacuum pump, rather than refrigerant, to discharge air when installing the unit.

4.4.1 Vacuum

- (1). Remove the caps of the liquid valve, gas valve and also the service port.
- (2). Connect the hose at the low pressure side of the manifold valve assembly to the service port of the unit's gas valve, and meanwhile the gas and liquid valves should be kept closed in case of refrigerant leak.
- (3). Connect the hose used for evacuation to the vacuum pump.
- (4). Open the switch at the lower pressure side of the manifold valve assembly and start the vacuum pump. Meanwhile, the switch at the high pressure side of the manifold valve assembly should be kept closed, otherwise evacuation would fail.
- (5). The evacuation duration depends on the unit's capacity, generally, 20 minutes for the 18K units, 30 minutes for the 24/30/36K units, 45 minutes for the 42/48K units. And verify if the pressure gauge at the low pressure side of the manifold valve assembly reads -1.0Mpa (145psig), if not, it indicates there is leak somewhere. Then, close the switch fully and then stop the vacuum pump.
- (6). Wait for some time to see if the system pressure can remain unchanged, 5 minutes for the 18/24/30K units, 10 minutes for the units 36/42/48K. During this time, the reading of the pressure gauge at the low pressure side can not be larger 0.005Mpa (0.72psig)..
- (7). Slightly open the liquid valve and let some refrigerant go to the connection pipe to balance the pressure inside and outside of the connection pipe, so that air will not come into the connection pipe when removing the hose. Note that the gas and liquid valve can be opened fully only after the manifold valve assembly is removed.
- (8). Place back the caps of the liquid valve, gas valve and also the service port.

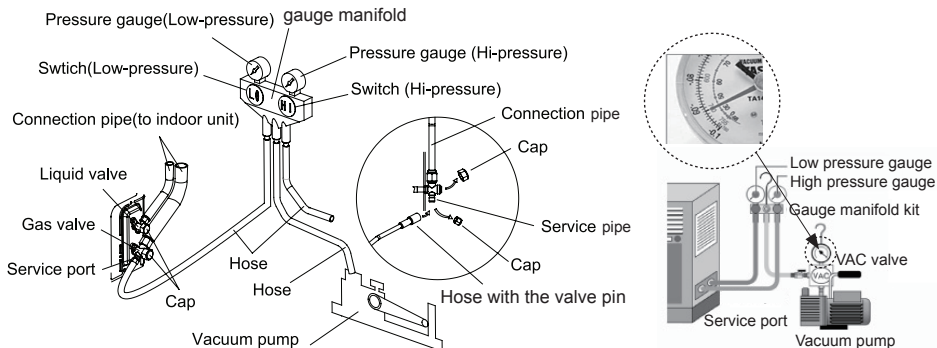

Fig. 4.17

Note: For 24K above units, it has the service port for both the gas valve and the liquid valve. During evacuation, it is available to connect two hoses of the manifold valve assembly to two service ports to quicken the evacuating speed.

4.4.2 Additional Charge

Refrigerant for the pipe length of 7.6m (25 feet) has been charged at the factory.

When the piping is longer than 7.6m(25feet), additional charging is necessary.

For the additional amount, see Table 4.6.

Table 4.6

Item \ Model	Additional Refrigerant Amount for Extra Pipe
18K	45g per 1.5 m (1.6 ounce per 5 feet)
24~48K	90g per 1.5 m (3.2 ounce per 5 feet)

When height difference between indoor unit and outdoor unit is more than 10m(30feet), an oil return bend should be added for every 6m(20feet). □□

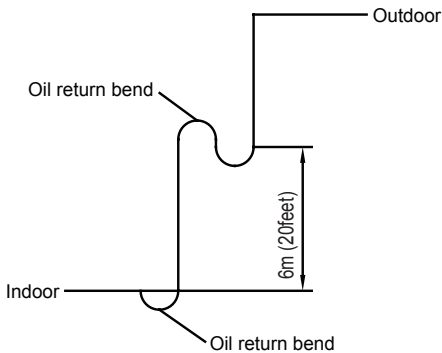

Fig.4.18

4.5 Installation of the Drain Hose

4.5.1 Precautions for Installing Drain Pipe

- (1). The drain pipe should be as short at possible and it should slope downwards.
- (2). Keep pipe size equal to or greater than that of the unit drain outlet/port size.
- (3). Drain hose should be installed as shown in below fig. 4.19.

Improper piping could cause water leaks .

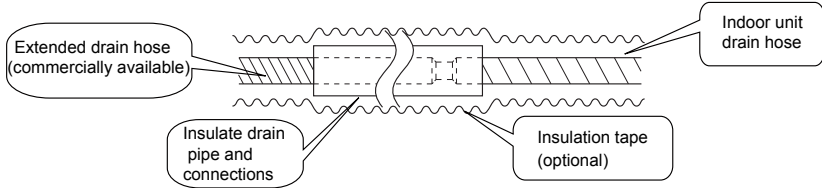

Fig.4.19

4.5.2 Installing the Drain Hoses

- (1). Insert the drain hose to the drain outlet of the unit and then secure with clamp and completely insulate pipe.
- (2). Connect the additional drain pipe to the drain , secure with clamp and completely insulate pipe.

<p>① ② ≤ 4mm (1/8inch)</p>	<p>① ② ③</p>
<p>Tighten the clamp until the screw head is less than 4mm (0.125inches) from the hose. Metal clamp Drain hose (accessory) Duct tape (accessory)</p>	<p>Insulate the pipe clamp and the drain hose using insulation . Metal clamp (accessory) Insulation (accessory)</p>

- (3). When connecting multiple drain pipes, install the pipes as Fig. 4.20. Select drain pipes size suitable for the operating capacity of the unit.

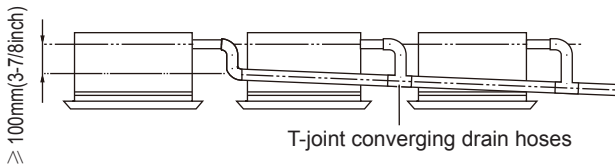

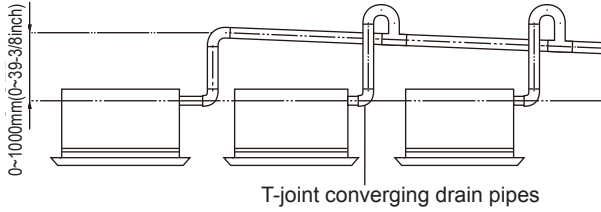

Fig.4.20

- (4). When the drain hose cannot keep a sufficient gradient for gravity flow, it is necessary to use a riser pipe (field supplied) to create a gradient.
- (5). If the air flow of indoor unit is high, this might cause negative pressure and result in return suction of outdoor air. Therefore, U-type water trap shall be designed on the drainage side of each indoor unit.(Fig. 4.21)
- (6). Install one water trap for each unit.

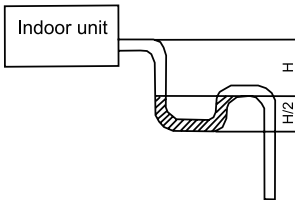

Fig. 4.21

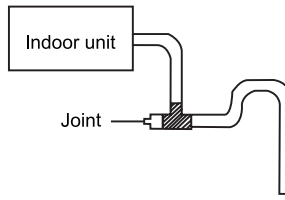

Fig. 4.22

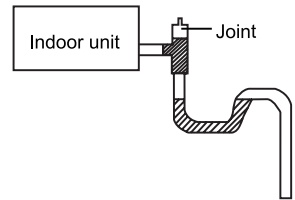
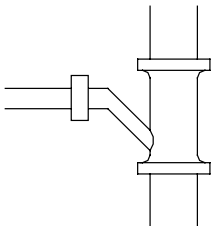

Fig. 4.23

- (7). Connection of drainage branch pipe to the main drainage pipe.

The horizontal pipe cannot be connected to the vertical pipe at a same height. It can be connected in a manner as shown below:

- 1: Attach the 3-way connection of the drainage pipe joint as shown in Fig. 4.24.
- 2: Attach the drain elbow as shown in Fig. 4.25.
- 3: Attach the horizontal pipe as shown in Fig. 4.26.



3-way connection of drainage pipe joint

Fig. 4.24

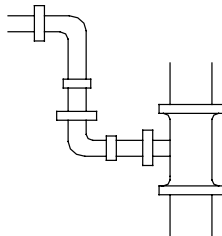

Connection of drain elbow

Fig. 4.25

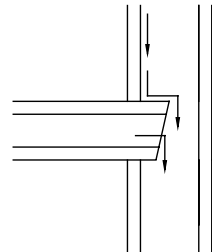

Connection of horizontal pipe

Fig. 4.26

4.5.3 Precautions When Using a Riser Pipe Type Drain System

- (1). Make sure that the entire drain pipe is completely insulated to prevent any possible water leakage due to condensation.
 - 1). Connect drain pipe to the riser pipe, and insulate completely.
 - 2). Connect unit drain outlet/port to the riser pipe, and insulate completely.

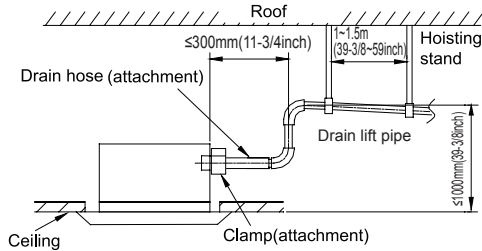

Fig. 4.27

- (2). Make sure the riser pipe is 280mm (11inch) maximum.
- (3). Stand the riser pipe vertically, and make sure it is not further than 300mm (12inch) from the base of the drain outlet.
- (4). Secure a downward gradient of 1/100 or more for the drain hose. To accomplish this, mount supporting brackets at an interval of 1~1.5 m(40-60inch).

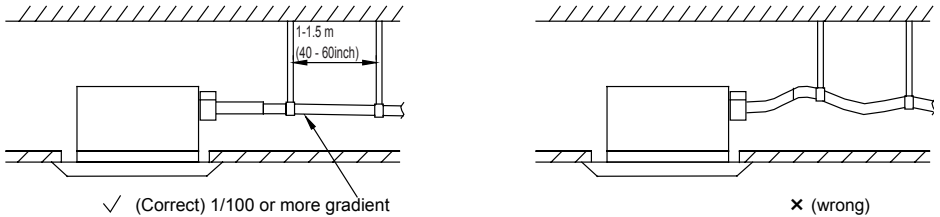

Fig. 4.28

- (5). The incline of attached drain hose should be 75mm(3inch) or less so that the drain outlet does not have to withstand additional force.

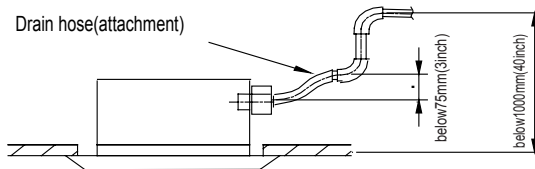

Fig. 4.29

4.5.4 Testing of Drain Piping

After piping work is finished, verify water flow.

Shown in the Fig. 4.30, add approximately 1 liter or 1 quart of water slowly into the unit drain pan and check drainage flow under COOL mode.

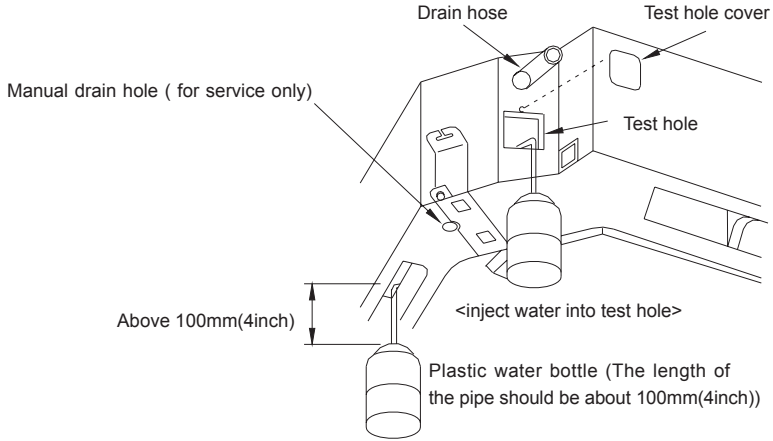

Fig. 4.30

4.6 Panel Installation

4.6.1 Precautions

- (1). See the figure below for the relationship of the front panel and the connection pipe.

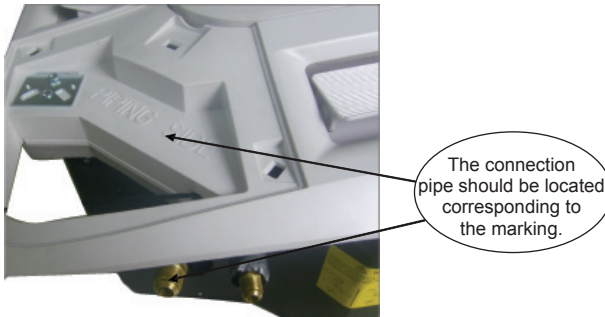

Fig. 4.31

- (2). Improper adjustment of the screws may cause condensate problems as shown in Fig. 4.32.

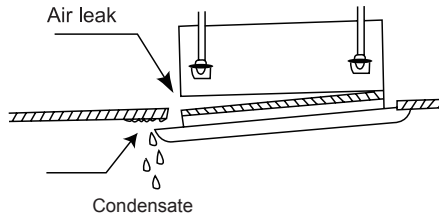

Fig. 4.32

- (3). If gap still exists between ceiling and decoration panel after tightening the screws, readjust

the height of the indoor unit. (Fig. 4.33)

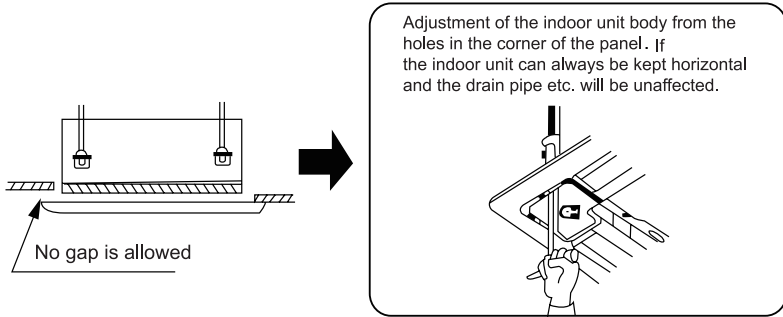

Fig. 4.33

- (4). Wire the swing louver motor as shown in Fig. 4.34.

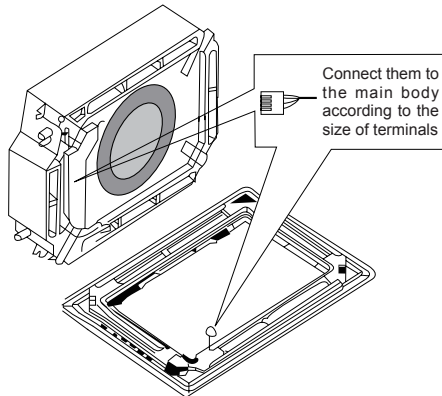

Fig. 4.34

4.6.2 Installing the Panel

- (1). Place the panel at the unit, and latch the hooks beside and opposite the swing flap motor.
- (2). Latch other two hooks.
- (3). Tighten four hexagonal screws under the latches about 15mm(5/8inch).
- (4). Adjust the panel along the direction indicated by the arrow as shown in Fig. 4.35.
- (5). Tighten the screws until the thickness of the sealing material between the panel and the indoor unit reduces to 5~8cm(1/4~3/8inch).

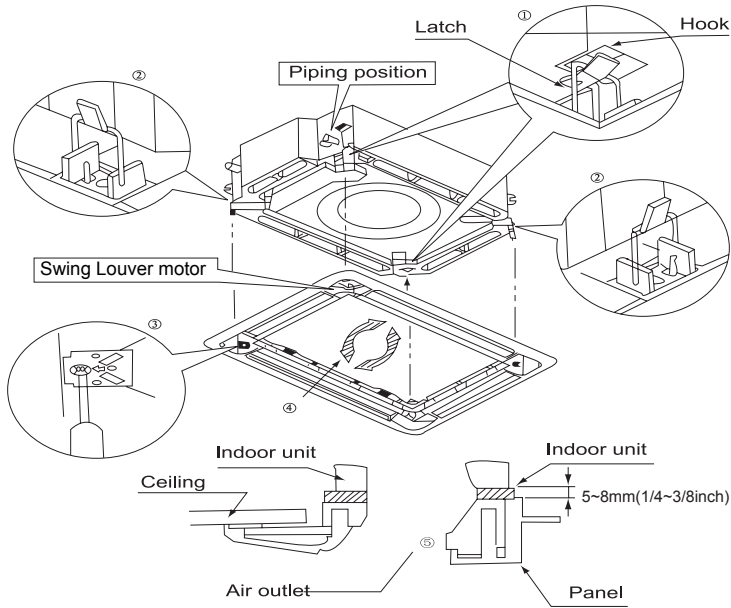

Fig. 4.35

4.7 Electrical Wiring

4.7.1 Wiring Precautions

⚠ WARNING

- | |
|---|
| ① . Before obtaining access to electrical terminals, disconnect all electrical power . |
| ② . Before turning on the unit, verify that the voltage is within the 187~252V range(for single pharse unit). |
| ③ . Always use a independent circuit and install a independent outlet to supply power to the air conditioner. |
| ④ . Use a circuit breaker and independent outlet for the electrical rating of the air conditioner. |
| ⑤ . Wiring work should be performed according to national electrical (NEC) and local standards. so that the air conditioner can operate properly. |
| ⑥ . Install a leakage circuit or GFI breaker in accordance with the related laws and regulations and electric company standards. |

⚠ CAUTION

① . When the air conditioner won't start due to low voltage, please contact a licensed electrician.

4.7.2 Electrical Wiring

(1). For solid core wiring (Fig. 4.36)

- 1). Cut the wire end with a wire cutter or wire-cutting pliers, then strip the insulation about 25mm (1inch).
- 2). Using a screwdriver, remove the terminal screw(s) on the terminal board.
- 3). Using pliers, bend the solid wire to form a loop suitable for the terminal screw.
- 4). Shape the loop wire properly, place it on the terminal board and tighten securely with the terminal screw using a screwdriver.

(2). For strand wiring (Fig. 4.36)

- 1). Cut the wire end with a wire cutter or wire-cutting pliers, then strip the insulation about 10 mm (3/8inch) .
- 2). Using a screwdriver, remove the terminal screw (s) on the terminal board.
- 3). Using a round terminal fastener or pliers, securely clamp a round terminal to each stripped wire end.
- 4). Position the round terminal wire, and replace and tighten the terminal screw with a screwdriver.(Fig. 4.37)

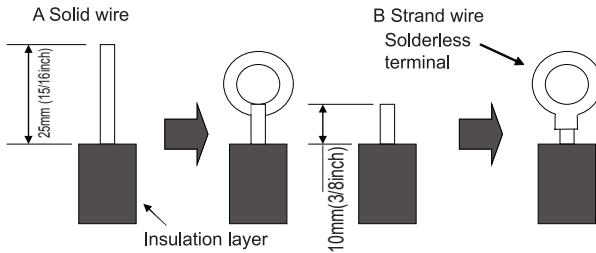

Fig. 4.36

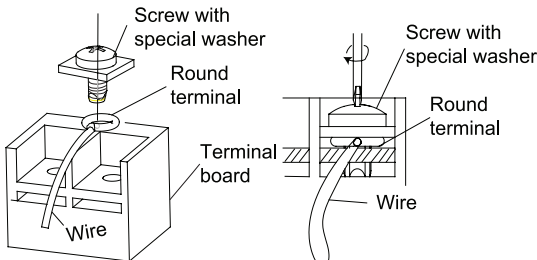

Fig. 4.37

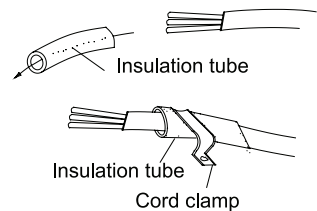

Fig. 4.38

(3). How to fasten connection wire and power wire by cord clamp

After passing the connection wire and power wire through the access hole, secure it with the cord clamp.(Fig. 4.38)

⚠WARNING	
① .	Before starting work, verify electrical power is disconnected to the indoor and outdoor units.
② .	Match the terminal block numbers and connection wire colors with those of the indoor unit .
③ .	Incorrect wiring may cause burning of the electric parts.
④ .	Connect all wires firmly to the terminal block. Improper installation may cause a fire.
⑤ .	Always fasten the outside covering of the connection wire with wire clamps. (If the insulator is not clamped, electric leakage may occur.)
⑥ .	Always properly connect the ground wire.

(4). Electric wiring between the indoor and outdoor units

Single-phase units(18K~30K)

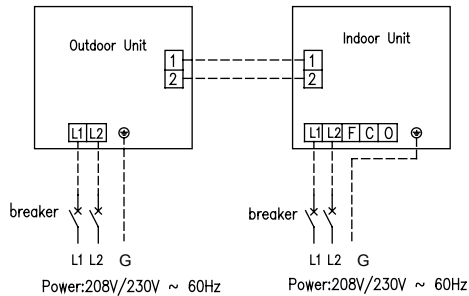

Single-phase units(36K~48K)

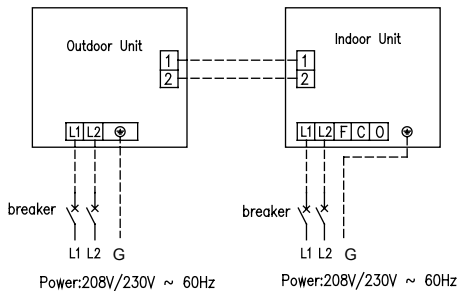

Fig. 4.39

(5). Electric wiring of indoor unit side

Remove the electric box cover from the electric box sub-assy and then connect the wire.

U-match Series Cassette Type Unit

18-42K:

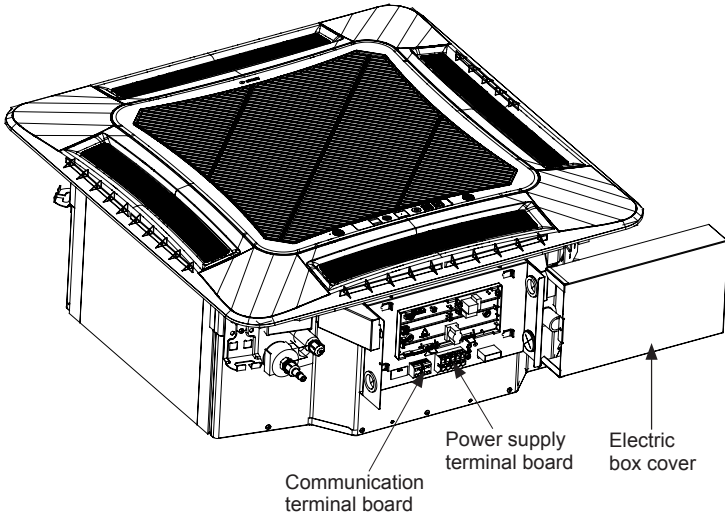

48K:

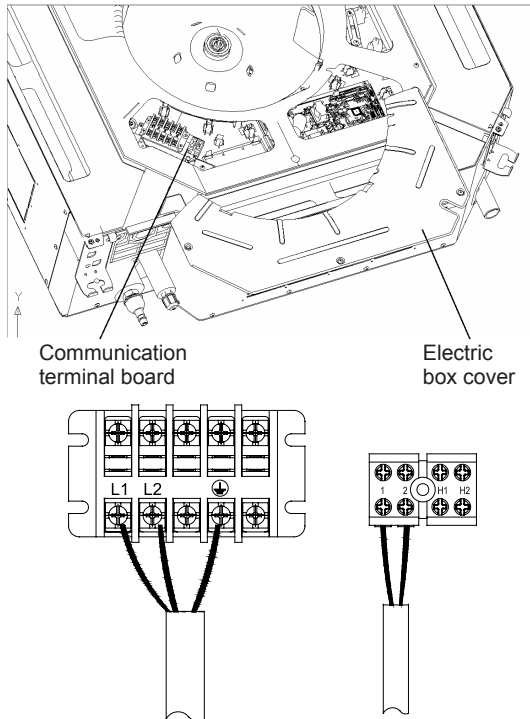

Fig. 4.40

⚠ CAUTION

- ① . The fresh air damper and power wires are high-voltage, while the communication wire and wired controller are low-voltage. They should be run separately to avoid electromagnetic interference.
- ② . High-voltage and low-voltage lines should enter the electrical control box through separate access holes.
- ③ . Do not bundle the wired controller and the communication wire together, or arrange them in parallel, otherwise improper operation would occur.
- ④ . High-voltage and low-voltage lines should be fixed separately and securely, with internal big clamps for the former and small clamps for the latter.
- ⑤ . Tighten the indoor/outdoor communication wires and power wire respectively on the terminal boards with screws. Faulty connection may cause a fire.
- ⑥ . If the communication wires of indoor unit (to the outdoor unit) and power wire are connected incorrectly, the air conditioner may be damaged.
- ⑦ . Connect the communication wires of indoor unit properly based on the corresponding marks as shown in shown in Fig. 4.39.
- ⑧ . Properly ground both indoor and outdoor units directly to an earth ground.
- ⑨ . Unit shall be grounded in compliance with the applicable local and national codes.

(6). Electric wiring of outdoor unit

NOTICE! When connecting the power wire, make sure that the phase of the power supply matches with the exact terminal board. If not, the compressor will rotate reversely and run improperly.

Remove the big handle (18~30K) /front panel (36~48K) of the outdoor unit and insert the end of the communication wire and the power wire into the terminal board.

Single phase:

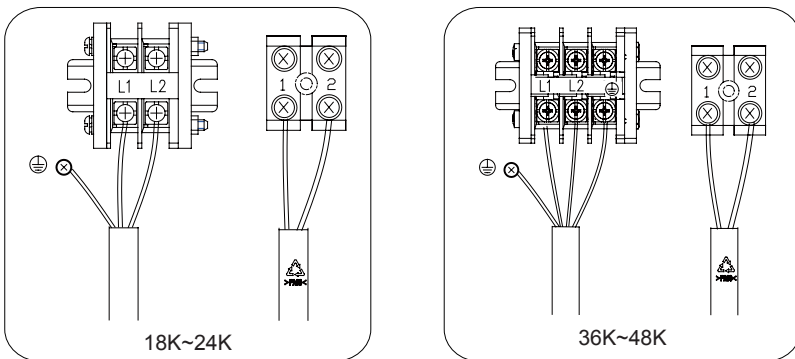

Fig. 4.41

5 Installation of Controllers

Refer to the Installation Manual of the controller for more details.

6 Test Running

6.1 Trial Operation and Testing

(1). The meaning of error codes as shown below:

Table 6.1

Number	Error code	Error	Remarks
1	E1	Compressor high pressure protection	
2	E2	Indoor anti-freeze protection	
3	E3	Compressor low pressure protection, refrigerant-lacking protection and refrigerant collecting mode	
4	E4	Compressor high discharge temperature protection	
5	E6	Communication error	
6	E8	Indoor fan motor error	
7	E9	Full water protection	
8	F0	Indoor ambient temperature sensor error	
9	F1	Evaporator temperature sensor error	
10	F2	Condenser temperature sensor error	
11	F3	Outdoor ambient temperature sensor error	
12	F4	Discharge temperature sensor error	
13	F5	Temperature sensor error of wired controller	
15	C5	Capacity code error	
16	EE	Outdoor memory chip error	
17	PF	Electric box sensor error	
18	H3	Compressor overload protection	
19	H4	Overloading	
20	H5	IPM protection	
21	H6	DC fan motor error	
22	H7	Drive desynchronizing protection	
23	HC	PFC protection	
25	Lc	Activation failure	
26	Ld	Compressor phase sequence protection	
27	LE	Compressor stalling protection	
28	LF	Power protection	
29	Lp	Mismatching between indoor unit and outdoor unit	
30	U7	4-way valve direction changing protection	
31	P0	Drive reset protection	

32	P5	Over-current protection	
33	P6	Communication error between main control and drive	
34	P7	Drive module sensor error	
35	P8	Overheating protection of drive module	
36	P9	Zero-crossing protection	
37	PA	AC current protection	
38	Pc	Drive current error	
39	Pd	Sensor connecting protection	
40	PE	Temperature drift protection	
41	PL	Busbar low voltage protection	
42	PH	Busbar high voltage protection	
43	PU	Charge loop error	
44	PP	Input voltage abnormality	
45	ee	Drive memory chip error	

NOTICE! When the unit is connected with the wired controller, the error code will be simultaneously shown on it.

(2). Description of the Indicators on the Panel of the Cassette Unit.

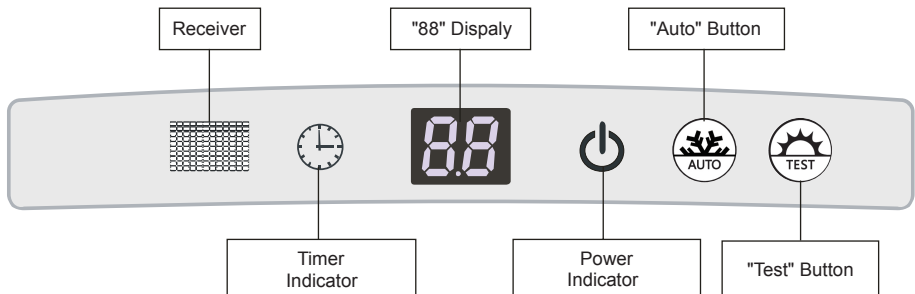

Fig. 6.1

◆ Power and ON/OFF Indicators:

It goes red when the unit is powered on. It turns white when the unit has started.

◆ Timer Indicators:

It goes on when the timer is set and is off when it is not. Its display is in yellow.

◆ "88" Display:

When there is no error, and it receives valid remote control information. It will display the room set temperature for 5s, then display indoor ambient temperature. When the unit has error, It will display the error code. When there are more than one error, the error code will be displayed alternately.

6.2 Working Temperature Range

Table 6.2

Test Condition	Indoor Side		Outdoor Side	
	DB °C(°F)	WB °C(°F)	DB °C(°F)	WB °C(°F)
Nominal Cooling	26.7(80.0)	19.4(67.0)	35.0(95.0)	23.9(75.0)
Nominal Heating	21.1(70.0)	15.6(60.0)	8.33(47.0)	6.11(43.0)
Rated Cooling	26.7(80.0)	19.4(67.0)	46.1(115.0)	23.9(75.0)
Low Temp. Cooling	19.4(67.0)	13.9(57.0)	-18.0(0)	-
Rated Heating	26.7(80.0)	-	23.9(75.0)	18.3(65.0)
Low Temp. Heating	20.0(68.0)	-	-18.0(0)	-

Note:

- ① . The design of this unit conforms to the requirements of ARI 210/240-2008 standard.
- ② . If the static pressure is different, the air volume will be different, and then performance will be affected.
- ③ . Cooling (heating) capacity stated above is measured under nominal working conditions corresponding to standard external static pressure. The parameters are subject to change with the improvement of products, in which case the values on nameplate take precedence.
- ④ . In this table, there are two outside DB values under the low temp cooling conditions, and the one in the brackets is for the unit which can operate at extreme low temperature.

7 Troubleshooting and Maintenance

7.1 Troubleshooting

If your air conditioner suffers from abnormal operation or failure, first check the following points:

Table 7.1

Failure	Possible Reasons
The unit cannot be started.	<ol style="list-style-type: none"> ① . The power wire is not connected. ② . Electrical leakage of air conditioner causes tripping of the leakage switch or GFI Breaker. ③ . The operating buttons are locked. ④ . The control loop has failure.
The unit operates for a while and then stops.	<ol style="list-style-type: none"> ① . There is obstacle in front of the condenser. ② . The control loop is abnormal. ③ . Cooling operation is selected when the outdoor ambient temperature is above 46°C(115°F).

<p>Poor cooling effect.</p>	<ul style="list-style-type: none"> ① . The air filter is dirty or blocked. ② . There are heat sources or too many people inside the room. ③ . The door or window is open. ④ . There is obstacle at air inlet or air outlet. ⑤ . The set temperature is too high. ⑥ . There is refrigerant leakage. ⑦ . The performance of room temperature sensor becomes worse
<p>Poor heating effect</p>	<ul style="list-style-type: none"> ① . The air filter is dirty or blocked. ② . The door or window is not firmly closed. ③ . The set room temperature is too low. ④ . There is refrigerant leakage. ⑤ . The outdoor ambient temperature is lower than -5°C(20°F). ⑥ . Control loop is abnormal.

Note: After checking above items and taking relevant measures to deal it them, if the air conditioner still is not operating normally, please stop operation immediately and contact the local service center. Only ask qualified service technician to check and repair the unit.





7.2 Routine Maintenance

<i>NOTICE</i>	
① .	When the filter hasn't been installed, do not operate the air conditioner, otherwise, dust would come into the unit.
② .	Do not remove the air filter except for cleaning. Unnecessary handling may damage the filter.
③ .	Do not clean the unit with gasolene, benzene, thinner, polishing powder or liquid insecticide, otherwise it would cause discoloration and deformation .

WARNING! Do not wet the indoor unit may cause electric shock or fire hazard.

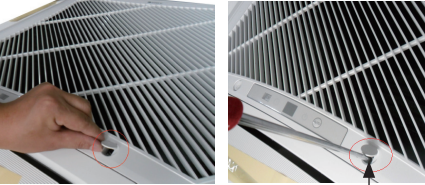
Increase the frequency of cleaning if the unit is installed in a room where the air is extremely contaminated.(cleaning the filter once every 3 months.)

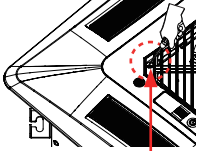
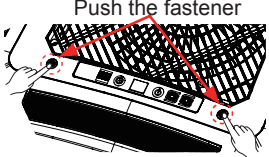
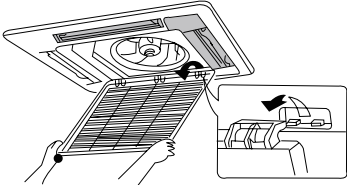
If dirt becomes impossible to be cleaned, replace the air filter.

How to clean the air filter	
<p>1. Open the air inlet grille</p> <p>(1). How to open the panel grille of the 24/42K cassette type unit</p> <ol style="list-style-type: none"> ① . Push the latch as shown in the figure. ② . Release the screws under clasps by a screwdriver. ③ . Release the fastener and open the panel grille. 	<div style="display: flex; justify-content: space-around;">  </div> <p style="text-align: center;">Remove the screw</p>  <p style="text-align: center;">Push the fastener</p>
<p>(2). How to open the panel grille of the 18K/48K/60K cassette type unit</p> <ol style="list-style-type: none"> ① . Remove the screws by a screwdriver as shown in the picture. ② . Release those two fasteners and open the panel grille. 	 <p style="text-align: center;">Remove the screw</p>  <p style="text-align: center;">Push the fastener</p>
<p>2. Disassemble the air inlet grille</p> <p>Open the air inlet grille at 45°, lift up and remove the grille.</p>	
<p>3. Disassemble the filter screen</p> <p>Draw out the filter screen and remove it.</p>	

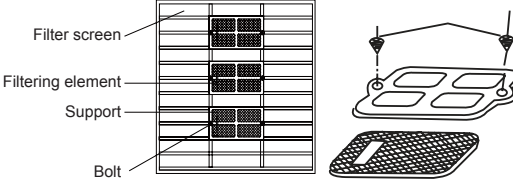
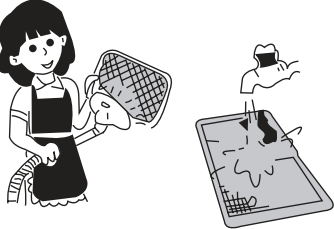
<p>4. Disassemble the air purifier Remove the air purifier after removing the fixed screws on it. (Accessory Only)</p>	
<p>5. Clean the filter screen Clean the filter screen by a vacuum cleaner or wash it by spraying water. If the oil stain on the filter can not be removed or cleaned up, wash it by warm water dissolved with the detergent. Dry the filter in the shadow. Note: ① . Never use hot water over 45°C(115°F) for preventing discolour. ② . Never dry it by fire so as to prevent fire hazard or deformation.</p>	
<p>6. Replace the air filter.</p>	<p>Same as step 3</p>
<p>7. Re-install grille assembly.</p>	<p>Same as step 1 and 2</p>

Cat No: UMATCH-CAS-10M
Version 0.0

Gree Electric Appliances, Inc ©2014



66129916511